

## Banchi multi grandezza

### Regolabili in altezza da 64 a 82cm

Banchi formato trapezoidale 95x57x40 in cinque diversi colori, con ruote frontali, vano porta-oggetti inferiore e porta tablet.

### H-ZGD65-MST

Grandezze 4-5-6-7 UNI EN 1729-1:2016





**Malva**  
H-ZGD65-VIGR-3-MST  
H-ZGD65-VIGR-2-MST



**Arancio**  
H-ZGD65-ORGR-3-MST  
H-ZGD65-ORGR-2-MST



**Giallo**  
H-ZGD65-YEGR-3-MST  
H-ZGD65-YEGR-2-MST



**Blu savoia**  
H-ZGD65-BLGR-3-MST  
H-ZGD65-BLGR-2-MST



**Verde acqua**  
H-ZGD65-GRGR-3-MST  
H-ZGD65-GRGR-2-MST



Le nuove metodologie didattiche rendono necessario riorganizzare la disposizione della classe in tempi brevi per assecondare le più svariate esigenze di apprendimento, garantendo al contempo la massima sicurezza di studenti e docenti. Per soddisfare questa esigenza abbiamo studiato una soluzione modulare completa di banchi, e sedie ergonomiche per postazioni circolari composte da più banchi.

Gli arredi per la **classe 3.0** si adattano alle diverse esigenze della scuola di oggi: dalle postazioni singole per la classica lezione frontale a configurazioni multiple a isola, a ferro di cavallo o lineari, capaci di ospitare gruppi di 2, 4, 6 o più studenti e perfetti per attività collaborative.

Tutti i banchi sono disponibili con diverse altezze per andare incontro alle diverse stature degli studenti e rispondono sia alla normativa CE sulla sicurezza che ai requisiti stabiliti dal D.Lgs. n. 81/2008. Sono inoltre certificati come UNI EN 1729-1:2016.

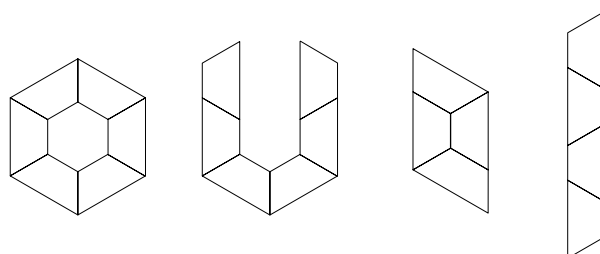
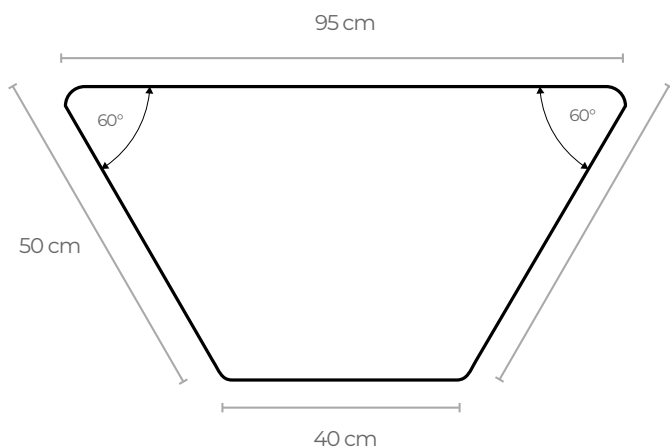

**Grandezza 4**

da 133 cm  
a 159 cm

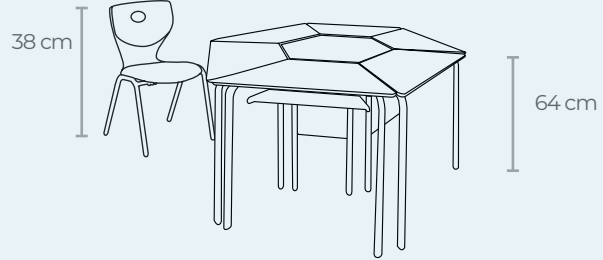
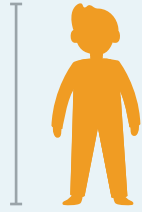

**Grandezza 5**

da 146cm  
a 176,5cm

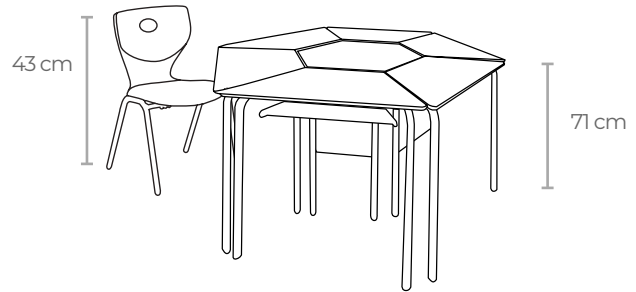
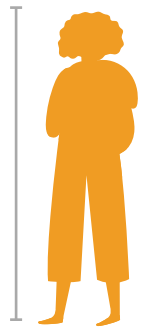

**Grandezza 6**

da 159cm  
a 188cm

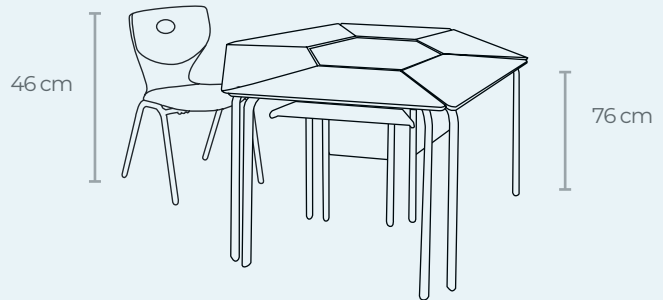
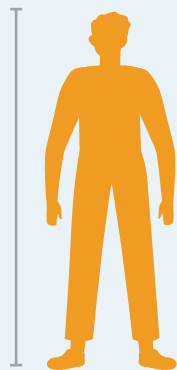

**Grandezza 7**

da 174cm  
a 207cm

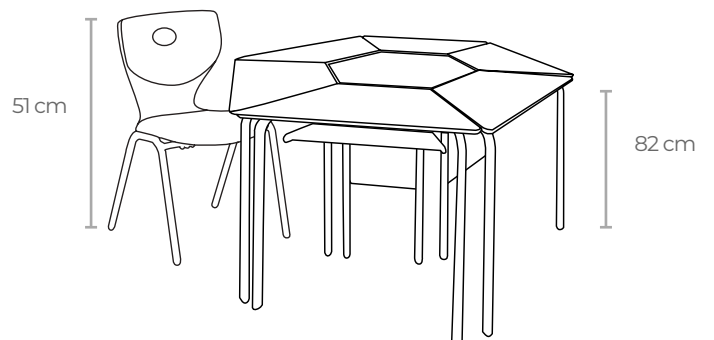
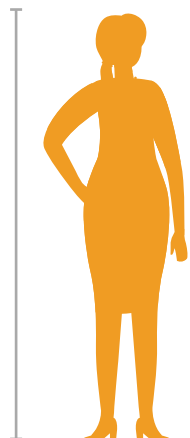

## Galleria prodotto



Vano porta-oggetti



Ampio spazio per le gambe



Porta tablet rimovibile

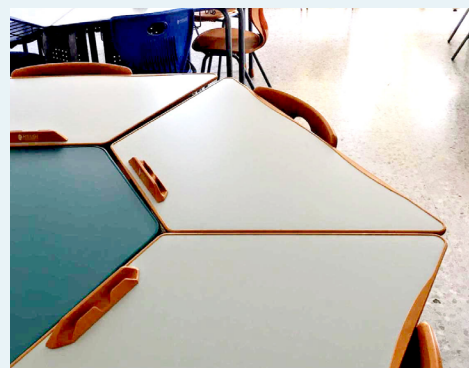

### Ambienti didattici

Modulabili, personalizzabili con diverse configurazioni disponibili

## Scheda Tecnica

Codice	GRANDEZZA	DIMENSIONI	COLORE	CONFEZIONE	SPECIFICHE TECNICHE
BANCHI TRAPEZOIDALI MULTI GRANDEZZA	H-ZGD65-GRGR-3-MST	4/5/6/7	Verde acqua/ Grigio	3 Banchi	<b>Struttura</b> Metallo verniciato a polveri epossidiche colore grigio chiaro.  <b>Piano di lavoro</b> Melaminico antigraffio sagomato arrotondato, bordato in ABS.  <b>Angoli</b> in 60°.
	H-ZGD65-GRGR-2-MST			2 Banchi	
	H-ZGD65-ORGR-3-MST	4/5/6/7	Arancio/Grigio	3 Banchi	
	H-ZGD65-ORGR-2-MST			2 Banchi	
	H-ZGD65-BLGR-3-MST	4/5/6/7	Blu savoia/ Grigio	3 Banchi	
	H-ZGD65-BLGR-2-MST			2 Banchi	
	H-ZGD65-YEGR-3-MST	4/5/6/7	Giallo/Grigio	3 Banchi	
	H-ZGD65-YEGR-2-MST			2 Banchi	
	H-ZGD65-VIGR-3-MST	4/5/6/7	Malva/Grigio	3 Banchi	
	H-ZGD65-VIGR-2-MST			2 Banchi	

## Ricambi

Disponibili ricambi singoli in tutti i colori



Porta Tablet

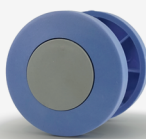

Ruote



Piedino per banco



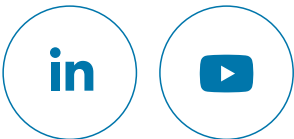

[www.HELGI-europe.com](http://www.HELGI-europe.com)

**HELGI Europe**  
education@helgi-europe.com  
business@helgi-europe.com

#250421H-ZGD65\_IT

Dealer